

**RF
NEXUS**

Product Datasheet

NEX15-EXT-KB1-001

Key Features

- LoRa
- Sigfox/Z-Wave/ISM
- 865/870 MHz
- Adhesive Mount
- Water Resistant
- Dimensions
75 × 20 x 7.7 mm



www.nexus-rf.com

1- Introduction

The NEX15-EXT-KB1-001 is a high-performance omnidirectional dipole antenna, specifically designed for adhesive mounting in SigFox, LoRa, and ISM network applications. Covering the widely used SigFox/LoRa/ISM frequency bands of 865/870 MHz, this antenna ensures reliable connectivity, making it an excellent choice for applications that require consistent performance in these networks.

The NEX15-EXT-KB1-001 features a robust ABS-UV resistant enclosure, making it perfectly suited for outdoor environments where durability and weather resistance are crucial. Its design allows it to maintain an omnidirectional radiation pattern, providing continuous and stable signal reception and transmission across all directions, ensuring dependable performance in even the most challenging conditions.

In addition to its rugged construction, the adhesive mounting option makes installation quick and convenient, offering flexibility in placement. This makes the NEX15-EXT-KB1-001 ideal for various outdoor and industrial applications where space and secure mounting are important considerations, without compromising on signal quality or reliability.

2- Specifications

Mechanical	
Size	75x20mm
Thickness	7.7 mm
Connector	SMA(M)
Casing	ABS(UV)
Weight	8.5g
Temperature Range	-40°C to 85°C
Electrical	
Frequency (MHz)	865/870
Return Loss (dB)	-15
VSWR	1.5:1
Efficiency	40%
Peak Gain (dBi)	3.4
Impedance	50Ω
Polarization	Linear
Pattern	Omnidirectional

*Data are given for 2m LMR100 cable.

3- Antenna Parameters

3.1- Return Loss

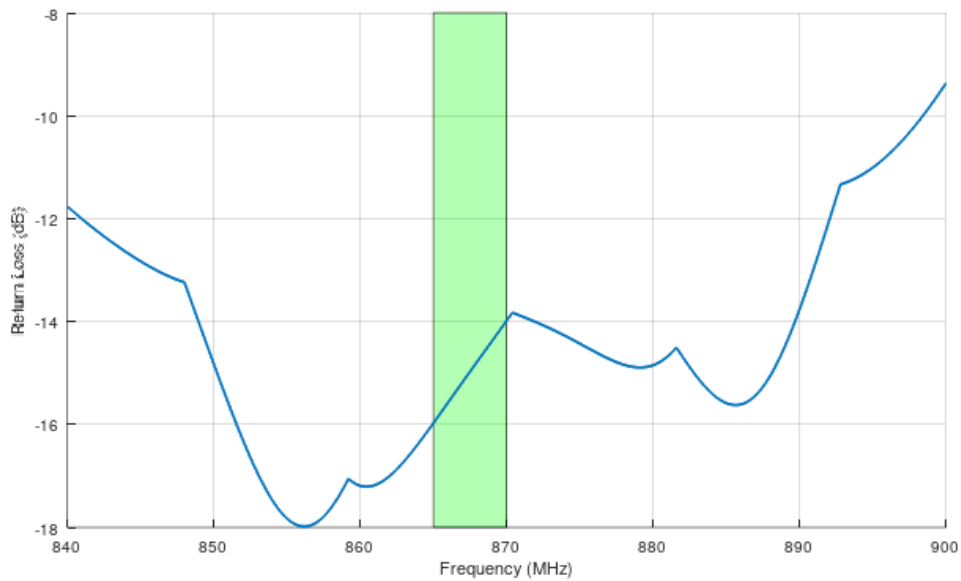

3.2- VSWR

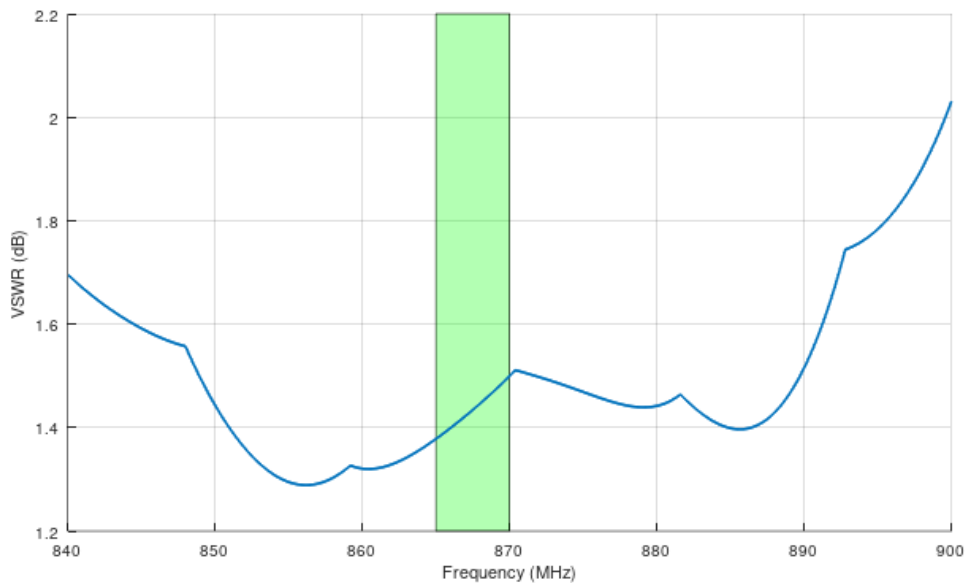

*Data are given for 2m LMR100 cable.

3.2- Efficiency

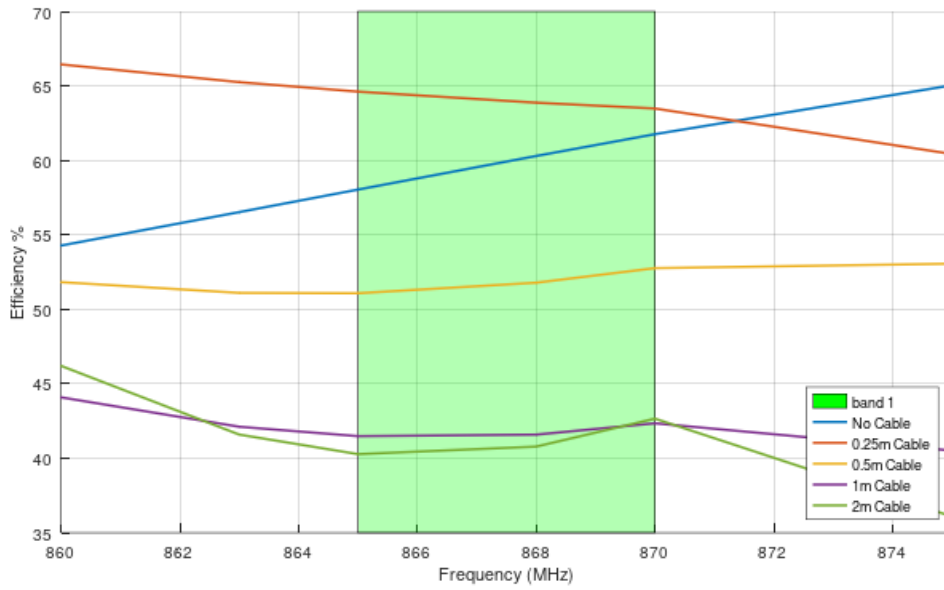

*Data are given for various LMR100 cable.

4- Radiator Patterns

4.1- Peak Gain

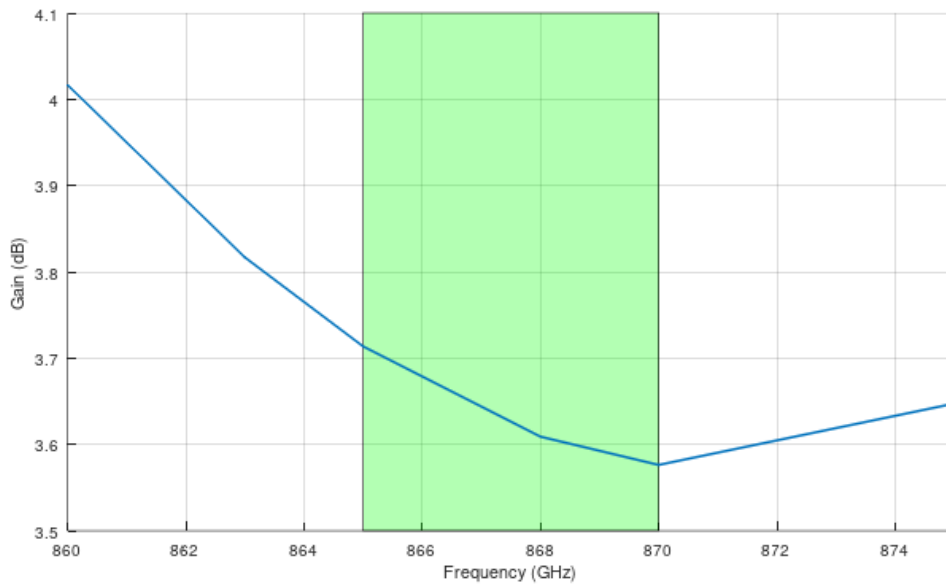

4.2- Average Gain

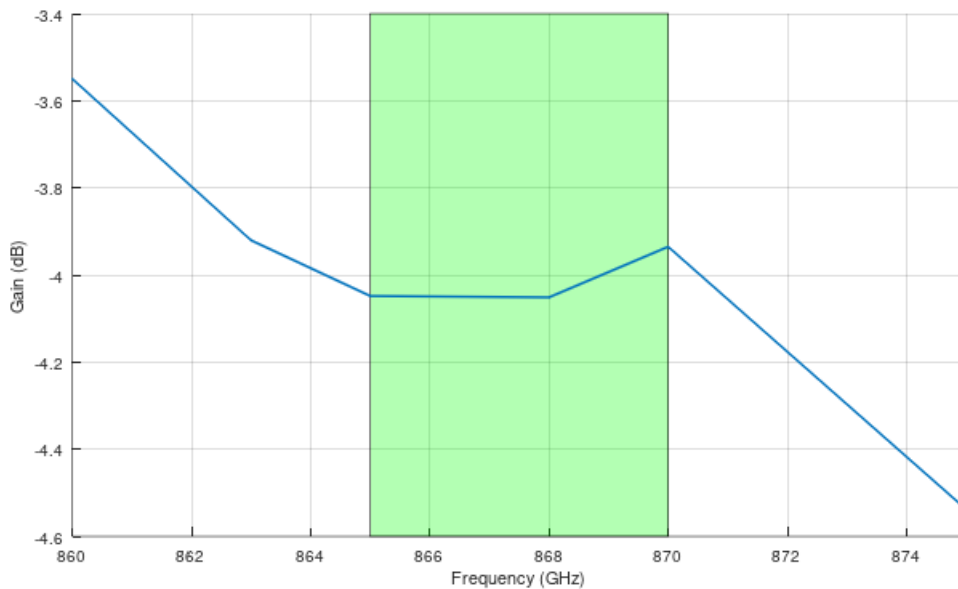

*Data are given for 2m LMR100 cable.

4.3- 868 MHz Pattern

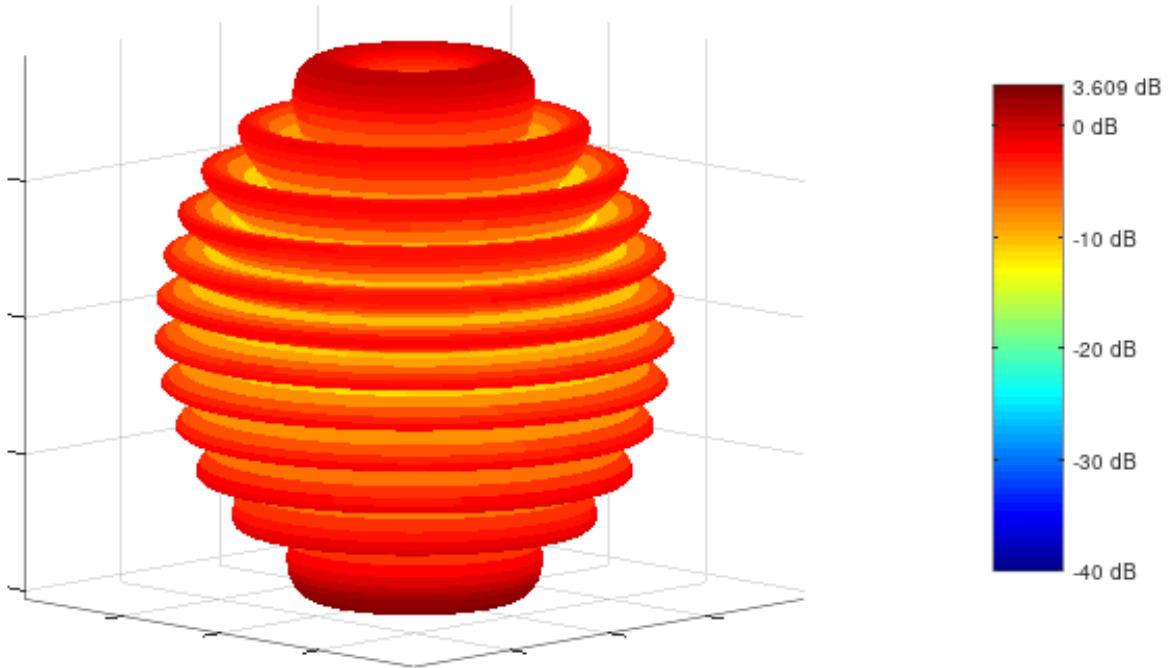

*Data are given for 2m LMR100 cable.

5- Technical Drawing

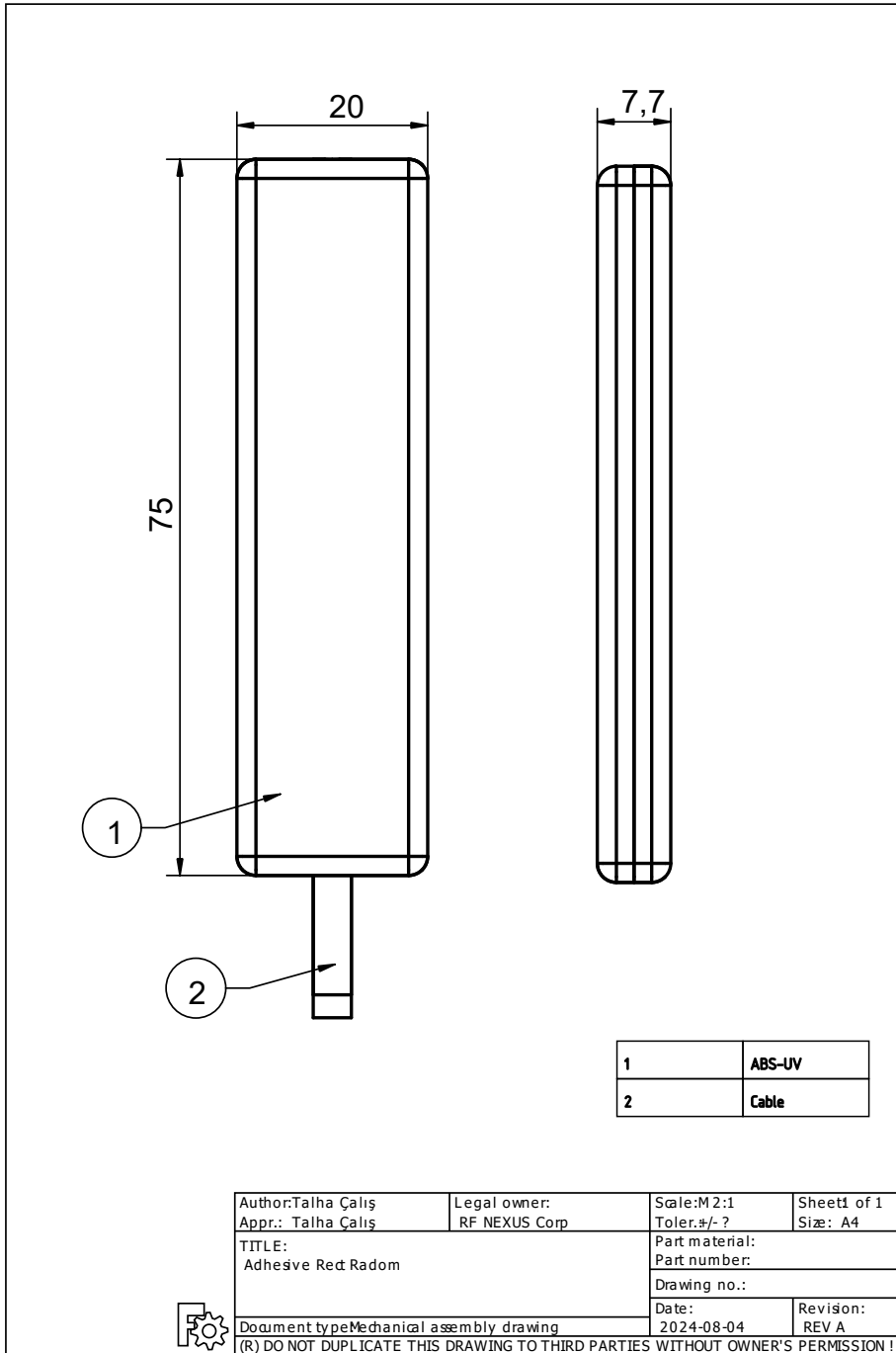

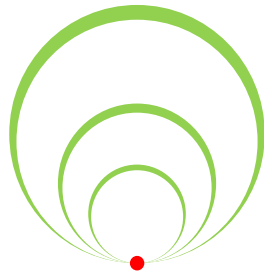

**RF
NEXUS**



+90 530-716-6670



www.nexus-rf.com



info@nexus-rf.com



**İvedikOSB Mh. 2224. Cad.
No:1 - 117/A
Yenimahalle / Ankara**